

Panel japonés motor / Motor japanese panel



AT8X9



MURTRA
1892

Welcome to our smart living

CONCEPT CREATION

Departamento de
Comunicación
Murtra 1892.
Communication and
image department
Murtra 1892

RENDERS

Montserrat Comunicació

PRINTING

Gràfiques Olsa

Copyright Industrias
Murtra S.A.

Ref. 9930201

V. 2022

**Nuestra filosofía
ha sido anticipar
el futuro buscando
soluciones para
el hogar y hacerlo
accesible a todos.**

*Our philosophy has
always been to
anticipate the future
researching solutions
for the home and
making it accessible to
everyone.*

**En Murtra abarcamos
3 siglos aportando
satisfactorias
soluciones estéticas
y funcionales para
el hogar a través
de la evolución de
las necesidades
y los espacios
residenciales y
comerciales.**

*In Murtra, we have
been providing
satisfactory aesthetic
and functional
solutions for the home,
over 3 centuries,
adapting our offer to
the evolution of needs
and residential &
commercial spaces.*

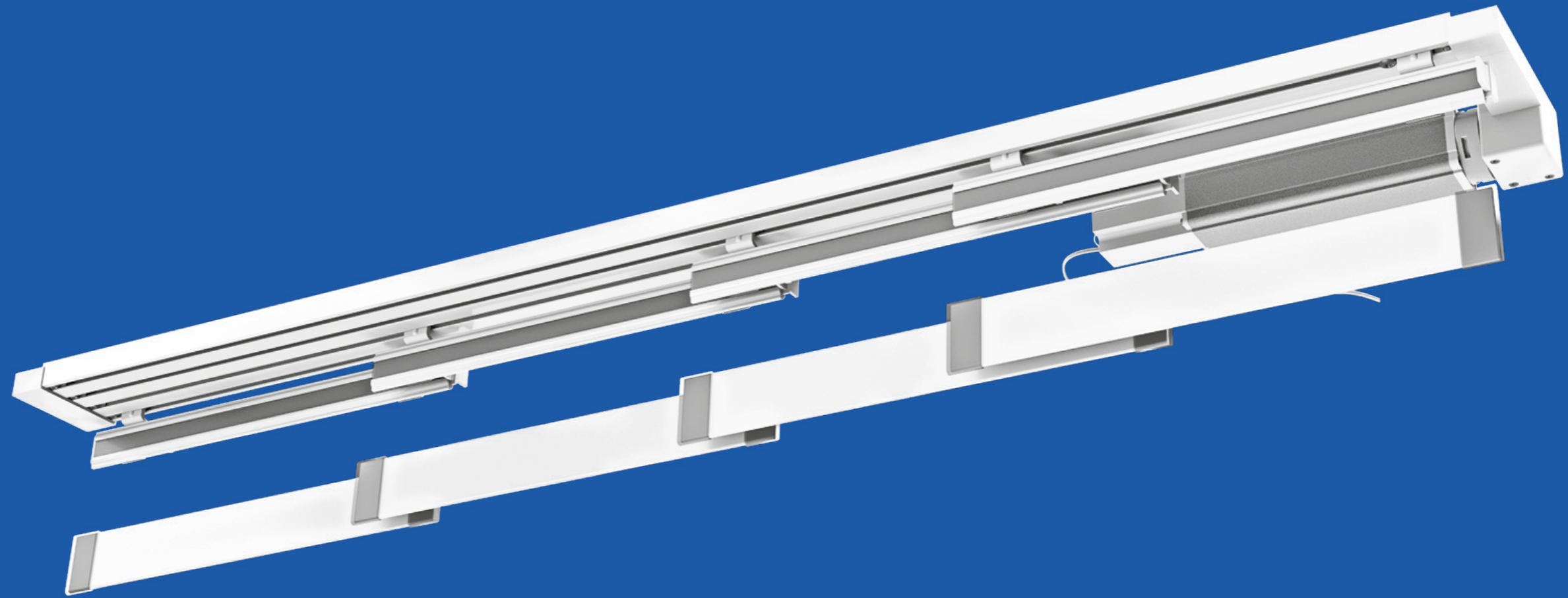

Panel motor AT8X9

Motor Japanese Panel AT8X9

Sistema muy silencioso.

Arranque y stop ralentizados.

Touch Control: Arranque automático al tirar del tejido.

Accionamiento manual en caso de falta de corriente eléctrica.

Stop After Resistance: Paro automático al engancharse el tejido en ventana o puerta.

Programación de límites y posiciones.

Acceso a Wifi mediante un dispositivo de fácil y rápida conexión.

Quiet DC motor.

Slow start and stop.

Touch control function: Automatic start when pulling the fabric.













Hand operated curtain in case of power failure.

Stop after resistance function: Automatic stop when the fabric is hooked in window or door.

Program of positions and limits.

Wifi access through an easy and fast connection transfer device.

Motor AT8X9

	Medidas motor <i>Motor dimensions</i>	60 x 339 x 40 mm
	Fuerza <i>Strength</i>	0.8 Nm
	Velocidad <i>Speed</i>	110 rpm 0,11 m/s
	Capacidad de carga <i>Load capacity</i>	30 kg
	Sonido <i>Noise</i>	<35 dB
	Voltaje <i>Power supply</i>	110-240 V
	Potencia <i>Power</i>	30 W
	Radio frecuencia <i>Radio frequency</i>	FSK 433.92 MHz
	Temperatura de trabajo <i>Working temperature</i>	-10 °C ~ 80 °C
	Mando a distancia <i>Remote control</i>	6 canales / 6 channels
	Pulsador <i>Switch</i>	1 canal / 1 channel
	Wifi	Alexa, Google Home, Apps...

Anodizado gris. Anodized grey
REF. V01450204 AT8X9

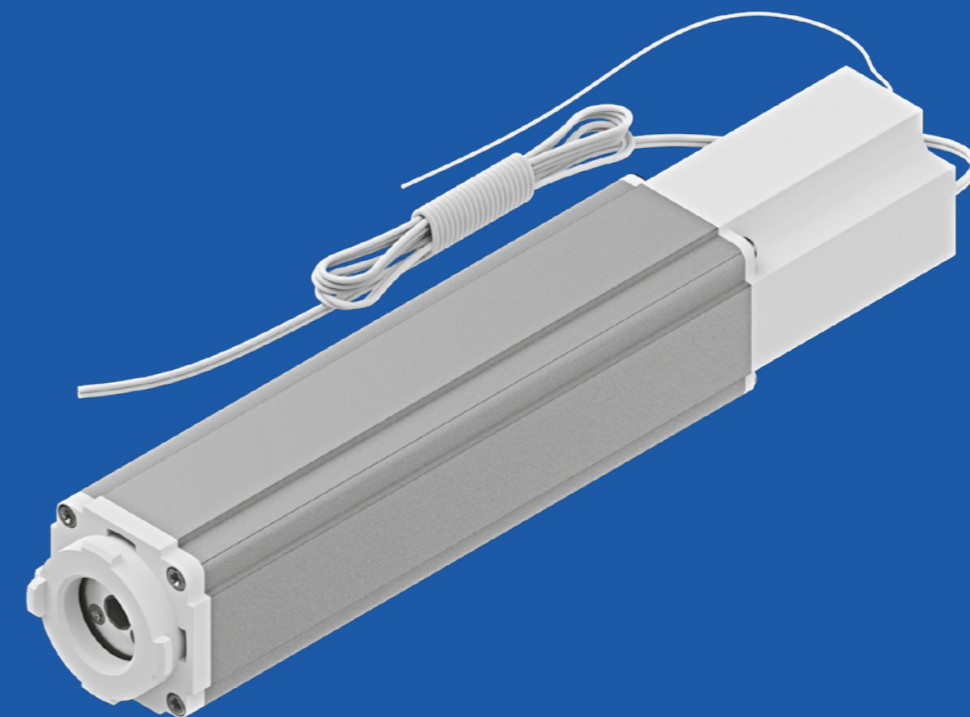

AT8X9 componentes

Components AT8X9

Guías motor derecha / izquierda.
Right / left motor guides
Refs. V022002 - V022004 - V022006 /
V022019 - V022020 - V022021

Motor AT8X9
Ref. V01450204

Soporte + Tornillo grapa motor.
Motor support + Staple screw
Refs. V125502 + V111148

Leva fijación. Ceiling clamp support
Ref. V022007

Perfil 5,7 m. 5,7 m. Profile
Refs. 12550701 - 125591 - 125516

Guías opuestas izquierda - derecha.
Left - right opposite guides
Refs. V022001 - V022003 - V022005

Correa dentada 6mm. Tooth belt 6mm.
Ref. 130094

1. Angular simple "L". Simple "L" angle
Ref. V027819

2. Corredera de rodillos. Roller glider
Ref. V027820

3. Portatela aluminio velcro 4,6 m.
4,6 m. Aluminium fabric holder
Ref. V027821

4. Angular doble "T". Double "T" angle
Ref. V027818

5. Ajuste trineo. Pilot runner adjuster
Ref. V022012

6. Clip correa dentada. Tooth belt clip
Ref. V022009

Firme final. End stop
Ref. V022008

Cable adaptador. Adaptor cable
Ref. V164064

Adaptador transformador 24V.
24V transformer adaptor
Ref. V166509

Carcasa para adaptador. Adaptor case
Ref. V140883

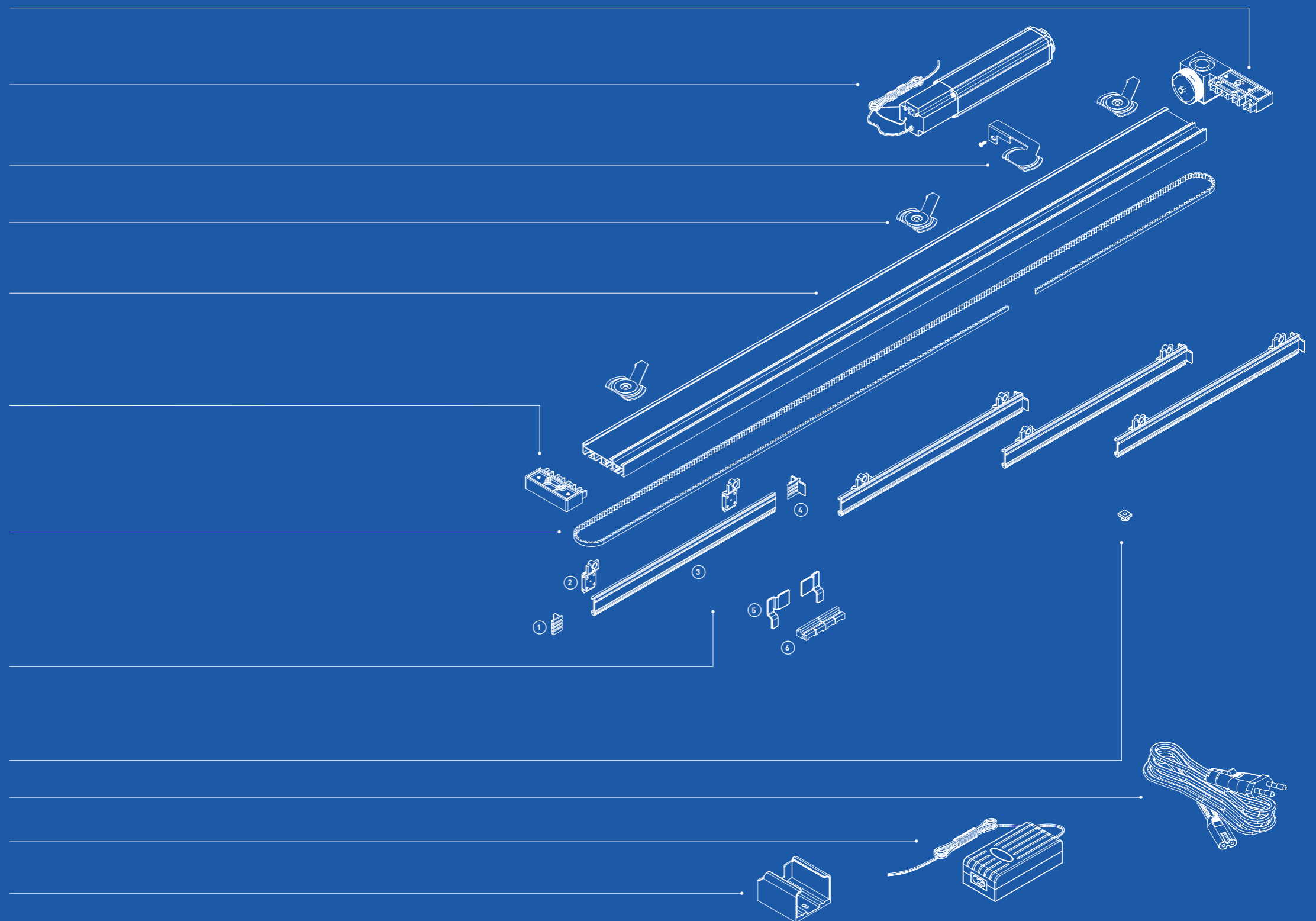

Accesorios sistema

System accessories



MOTOR AT-8X9. MOTOR AT-8X9
Aluminio. *Aluminium*
Anodizado gris. *Anodized grey*

Referencia Article Nr.	Unidad Venta Selling Unit
V01450204	1 pz

SOPORTE MOTOR. MOTOR SUPPORT
Acero. *Steel*
Cincado. *Zinc*



Referencia Article Nr.	Unidad Venta Selling Unit
V125502	5 pz

TORNILLO GRAPA MOTOR.
MOTOR STAPLE SCREW
Acero. *Steel*
Cincado. *Zinc*



Referencia Article Nr.	Unidad Venta Selling Unit
V111148	20 pz

PERFIL 3 VÍAS 5,7 m. 5,7 m. 3-TRACK PROFILE
Aluminio. *Aluminium*
Blanco. *White*



Referencia Article Nr.	Unidad Venta Selling Unit
12550701	57 m

PERFIL 4 VÍAS 5,7 m. 5,7 m. 4-TRACK PROFILE
Aluminio. *Aluminium*
Blanco. *White*



Referencia Article Nr.	Unidad Venta Selling Unit
125591	57 m

PERFIL 5 VÍAS 5,7 m. 5,7 m. 5-TRACK PROFILE
Aluminio. *Aluminium*
Blanco. *White*



Referencia Article Nr.	Unidad Venta Selling Unit
125516	57 m

GUÍA MOTOR 3 VÍAS DERECHA.
3-TRACK RIGHT GUIDE MOTOR
Nylon
Blanco. *White*



Referencia Article Nr.	Unidad Venta Selling Unit
V022002	1 pz

GUÍA MOTOR 3 VÍAS IZQUIERDA.
3-TRACK LEFT GUIDE MOTOR
Nylon
Blanco. *White*



Referencia Article Nr.	Unidad Venta Selling Unit
V022019	1 pz

GUÍA MOTOR 4 VÍAS DERECHA.
4-TRACK RIGHT GUIDE MOTOR
Nylon
Blanco. *White*



Referencia Article Nr.	Unidad Venta Selling Unit
V022004	1 pz

GUÍA MOTOR 4 VÍAS IZQUIERDA.
4-TRACK LEFT GUIDE MOTOR
Nylon
Blanco. *White*



Referencia Article Nr.	Unidad Venta Selling Unit
V022020	1 pz

GUÍA MOTOR 5 VÍAS IZQUIERDA.
5-TRACK LEFT GUIDE MOTOR
Nylon
Blanco. *White*



Referencia Article Nr.	Unidad Venta Selling Unit
V022021	1 pz

GUÍA OPUESTA IZQUIERDA / DERECHA 4 VÍAS.
4-TRACK OPPOSITE GUIDE LEFT / RIGHT
Nylon
Blanco. *White*



Referencia Article Nr.	Unidad Venta Selling Unit
V022003	5 pz

PORTATELA ALUMINIO VELCRADO 4,6 m.
4,6 m. ALUMINUM FABRIC HOLDER
Aluminio. *Aluminium*
Blanco. *White*



Referencia Article Nr.	Unidad Venta Selling Unit
027821	69 m

GUÍA MOTOR 5 VÍAS DERECHA.
5-TRACK RIGHT GUIDE MOTOR
Nylon
Blanco. *White*



Referencia Article Nr.	Unidad Venta Selling Unit
V022006	1 pz

GUÍA OPUESTA IZQUIERDA / DERECHA 3 VÍAS.
3-TRACK OPPOSITE GUIDE LEFT / RIGHT
Nylon
Blanco. *White*



Referencia Article Nr.	Unidad Venta Selling Unit
V022001	5 pz

GUÍA OPUESTA IZQUIERDA / DERECHA 5 VÍAS.
5-TRACK OPPOSITE GUIDE LEFT / RIGHT
Nylon
Blanco. *White*



Referencia Article Nr.	Unidad Venta Selling Unit
V022005	5 pz

ANGULAR DOBLE "T". DOUBLE "T" ANGLE
Nylon
Blanco. *White*



Referencia Article Nr.	Unidad Venta Selling Unit
V027818	50 pz

ANGULAR SIMPLE "L". SIMPLE "L" ANGLE
Nylon
Blanco. *White*



Referencia Article Nr.	Unidad Venta Selling Unit
V027819	50 pz

LEVA FIJACIÓN. CEILING CLAMP SUPPORT
Acero. *Steel*
Cincado. *Zinc*



Referencia Article Nr.	Unidad Venta Selling Unit
V022007	100 pz

FIRME FINAL. END STOP
Acero. *Steel*
Cincado. *Zinc*

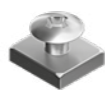

Referencia Article Nr.	Unidad Venta Selling Unit
V022008	20 pz

CORREDERA DE RODILLOS. ROLLER GLIDER
Nylon
Blanco. *White*



Referencia Article Nr.	Unidad Venta Selling Unit
V027820	100 pz

CORREA DENTADA 6 mm. TOOTH BELT 6 mm.
PU + Acero. PU + Steel
Verde. *Green*



Referencia Article Nr.	Unidad Venta Selling Unit
130094	400 m

CLIP CORREA DENTADA. TOOTH BELT CLIP
Nylon
Blanco. *White*



Referencia Article Nr.	Unidad Venta Selling Unit
V022009	20 pz

AJUSTE TRINEO. PILOT RUNNER ADJUSTER
Acero. *Steel*
Cincado. *Zinc*



Referencia Article Nr.	Unidad Venta Selling Unit
V022012	20 pz

ADAPTADOR TRANSFORMADOR 24V.
24V TRANSFORMER ADAPTATOR
Nylon
Blanco. *White*



Referencia Article Nr.	Unidad Venta Selling Unit
V166509	1 pz

CABLE ADAPTADOR. ADAPTATOR CABLE
Cobre. *Copper*
Blanco. *White*



Referencia Article Nr.	Unidad Venta Selling Unit
V164064	1 pz

MANDO A DISTANCIA CON PARADA CENTRAL 6 CANALES.
6 CHANNELS CENTRAL STOP REMOTE CONTROL
Nylon
Blanco. *White*



Referencia Article Nr.	Unidad Venta Selling Unit
V030258	1 pz

CABLE CONEXIÓN PULSADOR - DOMÓTICA.
CABLE CONNECTOR SWITCH - DOMOTIC
Cobre. *Copper*
Blanco. *White*



Referencia Article Nr.	Unidad Venta Selling Unit
V801999	1 pz

CARCASA PARA ADAPTADOR.
ADAPTATOR CASE
Nylon
Blanco. *White*



Referencia Article Nr.	Unidad Venta Selling Unit
V140883	1 pz

PULSADOR PARED 1 CANAL.
1 CHANNEL WALL SWITCH
Nylon
Blanco. *White*



Referencia Article Nr.	Unidad Venta Selling Unit
V032001	1 pz

CONVERTIDOR WIFI A RADIO 5V.
WIFI TO RADIO TRANSFER DEVICE 5V
Nylon
Blanco. *White*



Referencia Article Nr.	Unidad Venta Selling Unit
10301057	1 pz

Kit a medida

Made-to-measure kit

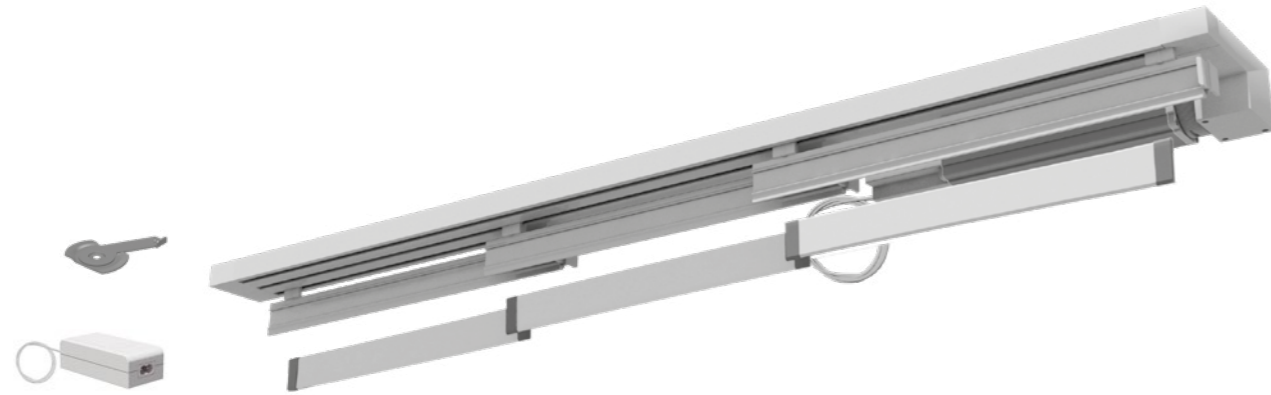

3 VÍAS 3 TRACKS

Blanco. *White*
Aluminio. *Aluminium*
Techo. *Ceiling installation*

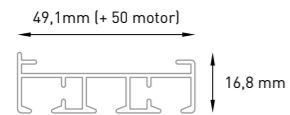

Ancho cm. <i>Width cm</i>	Referencia. <i>Article Nr.</i>	Unidad Venta. <i>Selling Unit</i>
150	9839.3 149.99	1
200	9839.3 199.99	1
250	9839.3 249.99	1
300	9839.3 299.99	1
350	9839.3 349.99	1
400	9839.3 399.99	1
450	9839.3 449.99	1
500	9839.3 499.99	1
570	9839.3 569.99	1

Opciones (No Incluido). *Options (Not Included)*

- Mando a distancia. *Remote control*
- Pulsador. *Switch*
- Cable conexión Pulsador - Domótica. *Cable connector Switch - Domotic*
- Convertidor wifi a radio. *Wifi to radio transfer device*

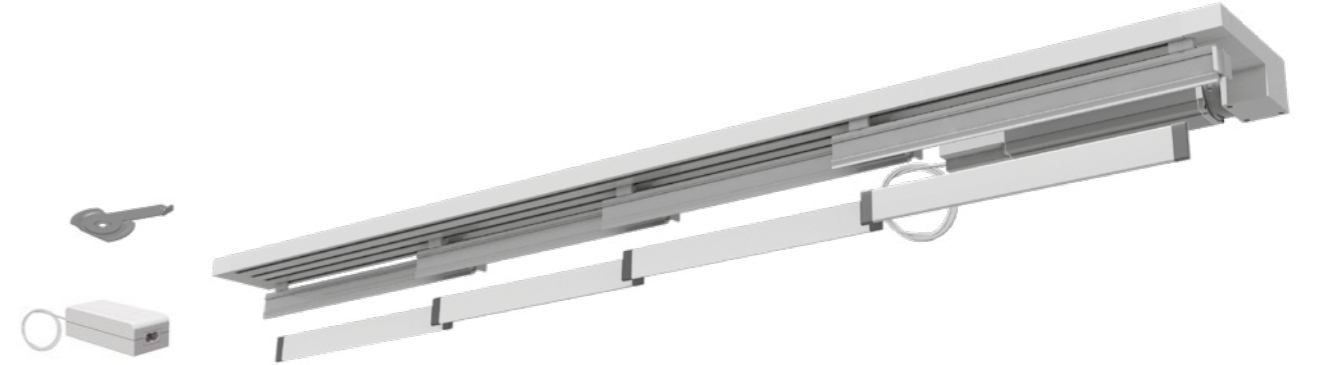

4 VÍAS 4 TRACKS

Blanco. *White*
Aluminio. *Aluminium*
Techo. *Ceiling installation*

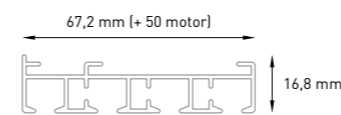

Ancho cm. <i>Width cm</i>	Referencia. <i>Article Nr.</i>	Unidad Venta. <i>Selling Unit</i>
150	9849.3 149.99	1
200	9849.3 199.99	1
250	9849.3 249.99	1
300	9849.3 299.99	1
350	9849.3 349.99	1
400	9849.3 399.99	1
450	9849.3 449.99	1
500	9849.3 499.99	1
570	9849.3 569.99	1

Opciones (No Incluido). *Options (Not Included)*

- Mando a distancia. *Remote control*
- Pulsador. *Switch*
- Cable conexión Pulsador - Domótica. *Cable connector Switch - Domotic*
- Convertidor wifi a radio. *Wifi to radio transfer device*





5 VÍAS
5 TRACKS

Blanco. *White*
Aluminio. *Aluminium*
Techo. *Ceiling installation*

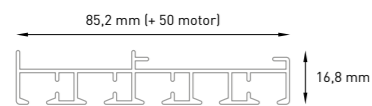

Ancho cm. <i>Width cm</i>	Referencia. <i>Article Nr.</i>	Unidad Venta. <i>Selling Unit</i>
150	9859.3 149.99	1
200	9859.3 199.99	1
250	9859.3 249.99	1
300	9859.3 299.99	1
350	9859.3 349.99	1
400	9859.3 399.99	1
450	9859.3 449.99	1
500	9859.3 499.99	1
570	9859.3 569.99	1

Opciones (No Incluido). Options (Not Included)

- Mando a distancia. *Remote control*
- Pulsador. *Switch*
- Cable conexión Pulsador - Domótica. *Cable connector Switch - Domotic*
- Convertidor wifi a radio. *Wifi to radio transfer device*



Opciones de recogida

Assembly options

AT839

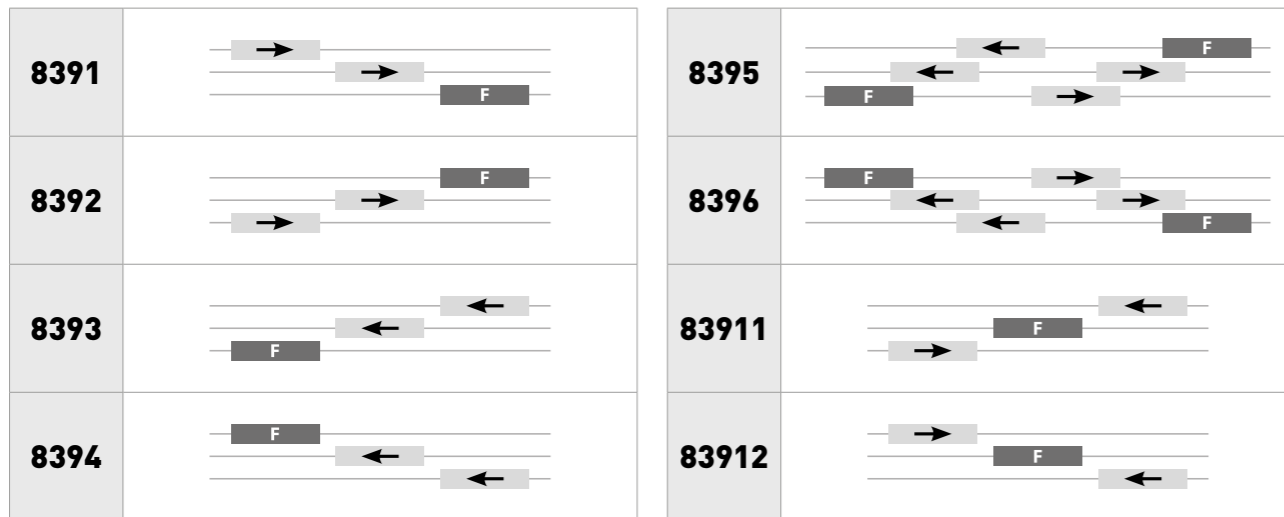

AT849

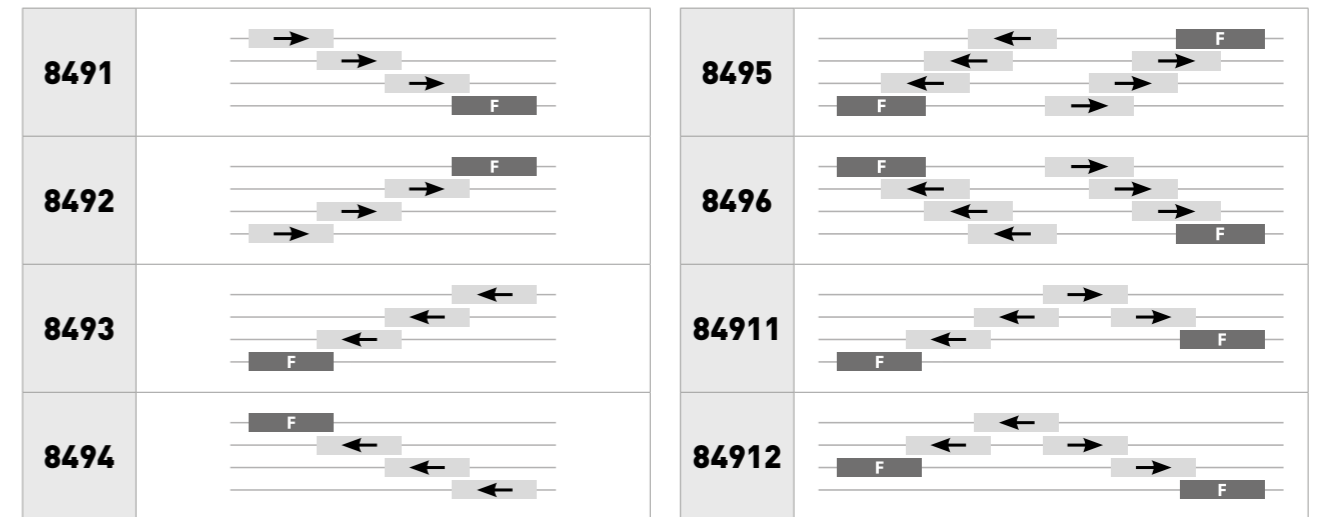

AT859



5 vías.
Tracks

8591		8595	
8592		8596	
8593		85911	
8594		85912	

	Panel Fijo. <i>Fixed Panel</i>
	Panel Libre 1 dirección. <i>Free Panel 1 direction</i>
	Panel Libre 2 direcciones. <i>Free Panel 2 directions</i>
	VÍAS / TRACK

Guía del usuario

User's guide



Instalación. *Installation*
Techo. *Ceiling*



Pesos máximos. *Max weight*
Panot. *Panel*
Cortina. *Curtain*



Recogidas. *Gathering*
Izquierda. *Left*



Recogidas. *Gathering*
Derecha. *Right*



Recogidas. *Gathering*
Central



Posiciones. *Postions*
Izquierda. *Left*



Posiciones. *Postions*
Derecha. *Right*



Seguridad infantil.
Child safety
EN 13120



Motor



Medidas motor.
Motor dimensions



Fuerza. *Strength*



Velocidad. *Speed*



Capacidad de carga.
Load capacity



Sonido. *Noise*



Voltaje.
Power supply



Potencia. *Power*



Radio frecuencia.
Radio frequency



Temperatura de trabajo.
Working temperature



Mando a distancia.
Remote control



Pulsador. *Switch*



Wifi

**moving
murtra**

**Industrias Murtra SA
Jordi Camp 94
08403 Granollers
Barcelona**

tel nacional + 34 938 467 225

tel export + 34 938 467 205

deco@murtra.com

murtra.com